



HAHN RENTALS

P.O. Box 490, Schumacher, ON P0N 1G0
 Phone: 866.754.9334
 Fax: 705.264.4401

BOOTH ACCESSORIES RENTALS

SAW TECH LOG & PRIVATE WOOD LOT EXPO
 Bancroft, JUNE 22 - 24, 2012

Company: _____ Booth#:
 Street: _____ City: _____
 Prov: _____ Postal Code: _____
 Phone#: _____ Fax#: _____
 Contact Person: _____

Card Holder Name: _____
 Credit Card Number: _____
 Signature _____
 Expiry Date _____ / _____
 Visa MasterCard Cheque NO AMEX

25% ADMINISTRATION CHARGE WILL APPLY TO ORDERS CANCELLED 2 WEEKS PRIOR TO SHOW.
 NO ORDER WILL BE PROCESSED UNTIL PAYMENT IS RECEIVED. ORDERS MUST BE PRE-PAID IN FULL
 BEFORE CLOSING AT 5 PM MONDAY PRIOR TO SHOW DATE TO RECEIVE PRE-SHOW PRICE.

#	DESCRIPTION	PRE-SHOW	ON SITE	QTY	TOTAL
1	PADDED ARM CHAIR	\$12.00	\$15.00		
2	DIRECTOR'S CHAIR, 30" HIGH	15.00	18.75		
3	BLACK/WOOD BAR STOOL WITH BACK	15.00	18.75		
4	FOLDING CHAIR	4.00	5.00		
5	CARPET: RED BLUE GREY GREEN 10' x 10' 10' x 20'	63.00 126.00	78.75 151.50		
	3/8" FOAM UNDERPAD (PRICE PER SQ. FT.)	0.50	0.75		
6	UNDRAPED TABLES: 30" W. BY 8' 6' 4' UNDRAPED TABLES: 18" W. BY 8' 6' 4'	16.75 16.75	21.00 21.00		
7	COFFEE TABLE (34" RND.) 18" HIGH 30" HIGH 42" HIGH	25.00	31.50		
8	SKIRTED TABLES (INCL. TABLE, PLASTIC COVER, FRONT & 2 SHORT SIDES SKIRTED) 8' 6' 4' 30" WIDE OR 18" WIDE ROYAL BLUE GOLD RED TEAL NAVY BLUE WHITE BLACK BURGANDY *** TO SKIRT 4 SIDES OR CHANGE TABLE SIZE	40.00 15.75	50.00 16.50		
9	LEG EXTENDERS (ELEVATES TABLE HEIGHT TO 42") BLUE WHITE OR BLACK SKIRTING ONLY	12.60	15.75		
10	2-BULB FLOODLIGHT	42.00	50.50		
11	3-BULB FLOODLIGHT	52.50	63.00		
12	EASEL	16.75	21.00		
13	SIGN STAND 22" x 28"	15.75	19.50		
14	COAT TREE	8.40	10.50		
15	COAT RACK C/W HANGERS	12.60	15.75		
16	WASTE BASKETS	6.30	7.85		
17	ARTIFICIAL PLANTS (4' TO 6') OR 2' LIVE PLANT	21.00	26.25		
18	A DEDICATED 15 AMP ELECTRICAL LINE	75.00	100.00		
19	FORK LIFT MOVE IN AND MOVE OUT	100.00	125.00		
Drapery	ROYAL BLUE GOLD RED TEAL GREEN NAVY BLUE WHITE BLACK BURGANDY 8' HIGH DRAPE BACK PRICE PER LINEAR FOOT 3' HIGH DRAPE SIDES PRICE PER LINEAR FOOT	5.50 3.40	6.80 4.20		

AUTHORIZING SIGNATURE: _____
 X _____

ALL RATES ABOVE ARE FOR DURATION OF SHOW. ALL CLAIMS/DISCREPANCIES MUST BE SETTLED PRIOR TO SHOW CLOSING.
 REFUNDS WILL NOT BE GIVEN ON ANY ORDERS CHANGED OR CANCELLED ON-SITE.
 ALL MATERIALS REMAIN THE PROPERTY OF HAHN RENTALS & WILL BE REMOVED UPON SHOW CLOSING.

SUBTOTAL: _____

13% HST: _____

GRAND TOTAL: _____

H.S.T. R104250493

Return By Fax No Later Than May 1, 2012



HAHN RENTALS

P.O. Box 490, Schumacher, ON P0N 1G0
 Phone: 866.754.9334
 Fax: 705.264.4401

BOOTH ACCESSORIES RENTALS

SAW TECH LOG & PRIVATE WOOD LOT EXPO
 Bancroft, JUNE 22 - 24, 2012

Company: _____ Booth#:

Street: _____ City: _____

Prov: _____ Postal Code: _____

Phone#: _____ Fax#: _____

Contact Person: _____

Card Holder Name: _____

Credit Card Number: _____

Signature _____

Expiry Date: _____ / _____

Visa
 MasterCard
 Cheque
 NO AMEX

POLE/PANEL SERIES

3' x 4' Panels
 16" x 4' Header Panels
 Silver, Charcoal, Royal Blue, Red, or Black

CUSTOM DESIGN OF ANY OF THESE
 EXHIBITS CAN BE ARRANGED.

With these modular components, you
 can order the following complete
 displays:

Poles (up to 8') Prices available upon request
 Panels (any size up to 3' x 4') Prices available upon request

- J - HP Portable Exhibit Systems
 - 10' Exhibit c/w 3 stem lights \$480.00
 - 20' Exhibit c/w 6 stem lights \$970.00
- K - VP Portable Exhibit Systems
 - 10' Exhibit c/w 4 stem lights \$480.00
 - 20' Exhibit c/w 8 stem lights \$970.00
- L - Basic Exhibit System (Lights extra) \$330.00
- M - Deluxe 20' Exhibit \$1080.00
 - 8 - 75w stem lights, and
 - 2 - 4' Trapezoidal Counters
- N - 10' Hexxa Black Pop-up Display \$475.00

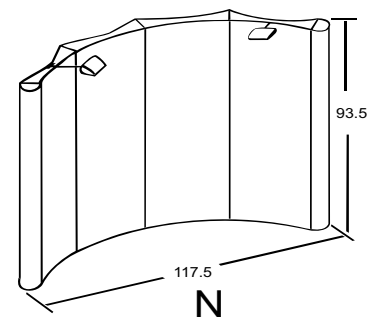
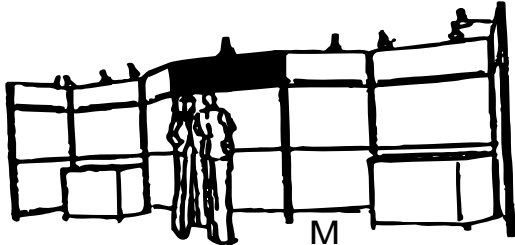
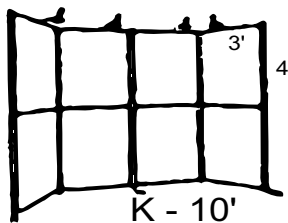
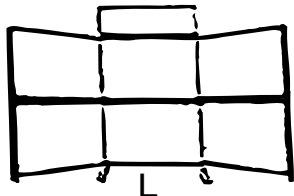
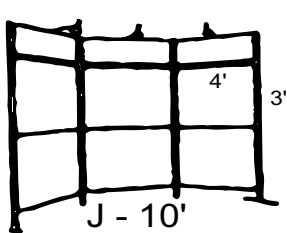

AUTHORIZING SIGNATURE:
 X _____

ALL RATES ABOVE ARE FOR DURATION OF SHOW. ALL CLAIMS/DISCREPANCIES MUST BE SETTLED PRIOR TO SHOW CLOSING.
 REFUNDS WILL NOT BE GIVEN ON ANY ORDERS CHANGED OR CANCELLED ON-SITE.
 ALL MATERIALS REMAIN THE PROPERTY OF HAHN RENTALS & WILL BE REMOVED UPON SHOW CLOSING.

SUBTOTAL: _____
 13% HST: _____
 GRAND TOTAL: _____
 H.S.T. R104250493



HAHN RENTALS

P.O. Box 490, Schumacher, ON P0N 1G0
 Phone: 866.754.9334
 Fax: 705.264.4401

BOOTH ACCESSORIES RENTALS

SAW TECH LOG & PRIVATE WOOD LOT EXPO
 Bancroft, JUNE 22 - 24, 2012

Company: _____ Booth#:

Street: _____ City: _____

Prov: _____ Postal Code: _____

Phone#: _____ Fax#: _____

Contact Person: _____

Card Holder Name: _____

Credit Card Number: _____

Signature _____

Expiry Date _____ / _____

Visa
 MasterCard
 Cheque
 NO AMEX

25% ADMINISTRATION CHARGE WILL APPLY TO ORDERS CANCELLED 2 WEEKS PRIOR TO SHOW.
 NO ORDER WILL BE PROCESSED UNTIL PAYMENT IS RECEIVED. ORDERS MUST BE PRE-PAID IN FULL
 BEFORE CLOSING AT 5 PM MONDAY PRIOR TO SHOW DATE TO RECEIVE PRE-SHOW PRICE.

EXHIBIT
 SYSTEMS
 RENTAL

FS 28 SERIES

FS 28/35" Folding Stackable 3 panel Display c/w 3 lights
 FS 28/12" Header
 Royal Blue, Silver, Charcoal Reversible

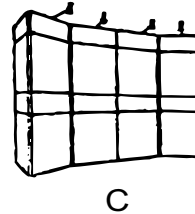
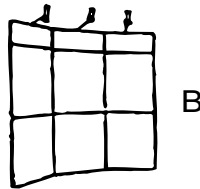
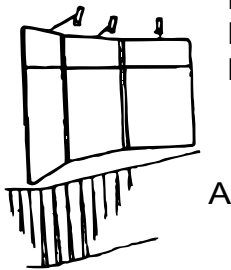

A - \$155.00
 B - \$190.00
 C - \$357.00

FS 28 SERIES

FS 28/35" Folding Stackable 4 panel Display c/w 4 lights
 FS 28/17" Header
 Royal Blue, Silver or Charcoal Reversible

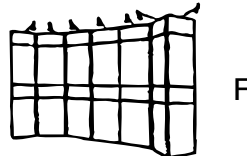
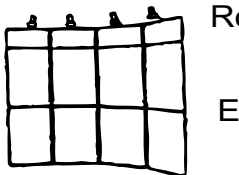

E - \$235.00
 F - \$500.00

FS PEDESTAL BASES AND TOPS

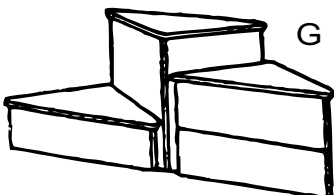

32.5" Triangular Counter Top - Silver (FS 28 Series Bases)
 26" Square Counter Top - Silver (FS 22 Series Bases)
 48" x 20" Trapezoidal Counter Top - Silver
 Bases are Royal Blue, Silver or Charcoal

G - 12"h - \$49.00
 24"h - \$55.00
 35"h - \$60.00
 H - 12"h - \$49.00
 24"h - \$55.00
 35"h - \$60.00
 I - 35"H - \$68.00

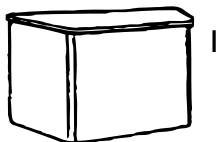
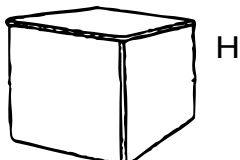

SUBTOTAL: _____

13% H.ST: _____

TOTAL: _____

REFUNDS WILL NOT BE GIVEN ON ANY CHANGED OR CANCELLED ORDERS ON-SITE.